

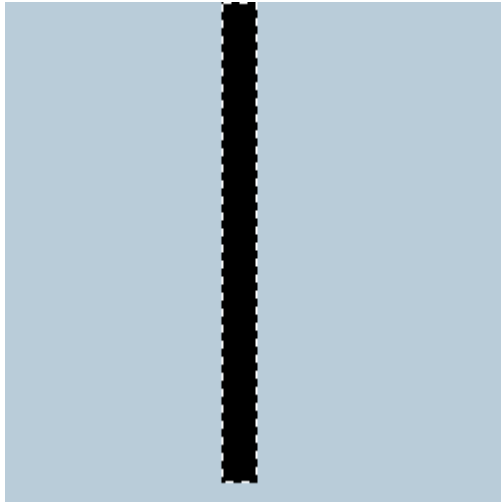

3D tentacles



Step 1

Create document 250x250 pixels. Fill it with #B9CCD9 color. Create a new layer name it "tentacle". Select rectangular marquee tool [M]. Make a shape similar to mine 18 width and 240 height pixels. Fill the selection with BLACK. Don't deselect it until I tell you.

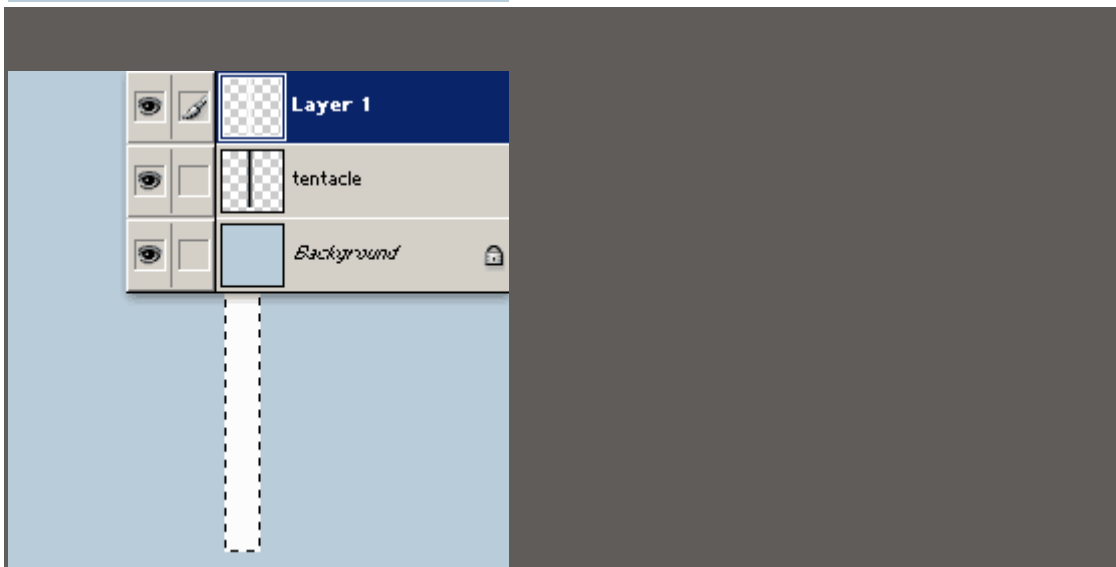

Step 2

Create a new layer above the tentacle layer. You don't have to rename it. I hope you have the selection still active. Fill it with #FCFCFC color. Now You should have two layers : Layer 1 and tentacle layer. Similar to the image on the left.



Step 3

Now apply Gaussian Filter to Layer 1. Filter>Blur>Gaussian Blur with radius 4. Merge both layers CTRL+E. Now you have one layer called tentacle. You can deselect your selection selection now.

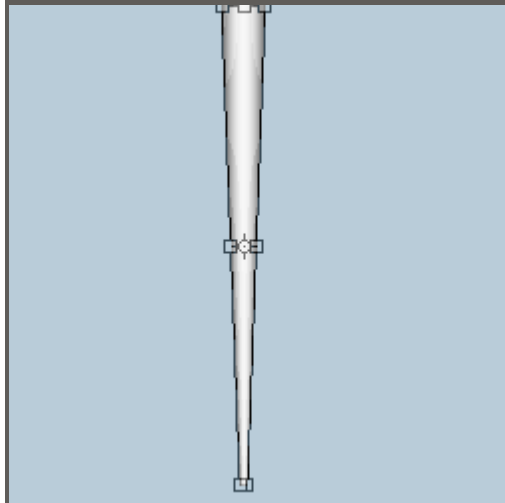

Step 4

Now all we have to do is distort it. Edit>Transform>Distort. Select right-bottom corner and using SHIFT+ALT move it to a little to the center. Do it the same with right-top corner but this time move it to the right. Watch my image.

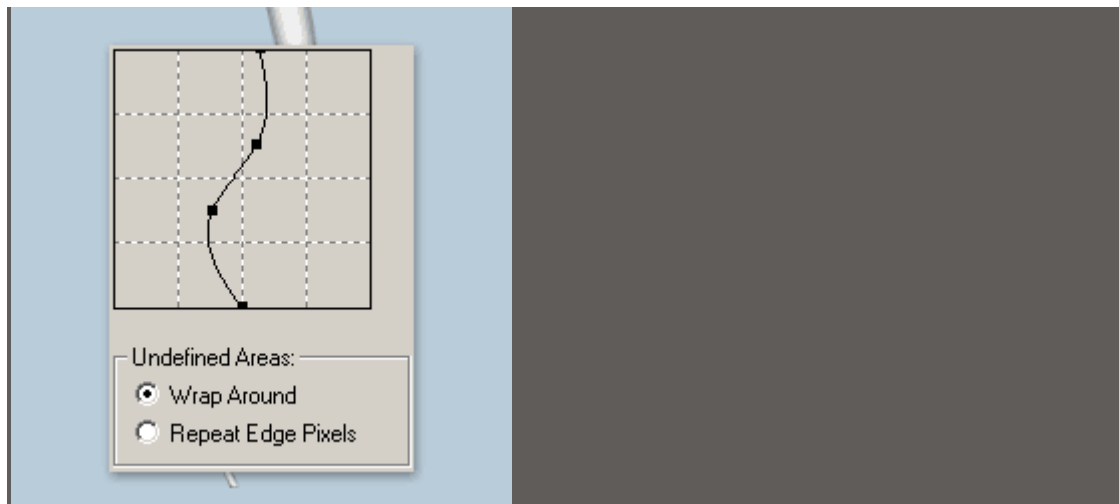

Step 5

Add Shear filter. Filter>Distort>Shear. You can make your own or use my settings.

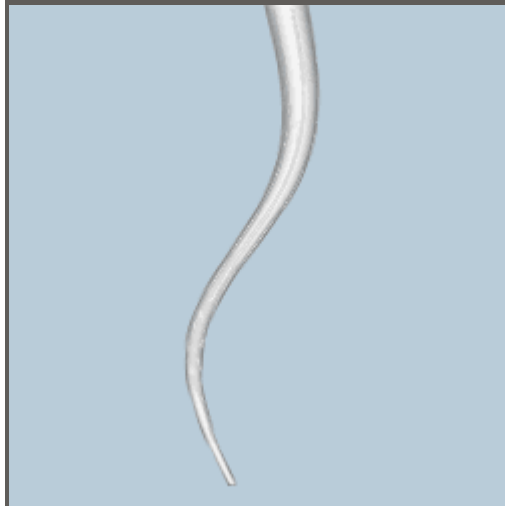

Step 6

Here is the most important part of this tutorial.

Add Plastic Wrap. Filter>Artistic>Plastic Wrap.

Settings: Highlight Strength : 9

Detail : 9

Smoothness : 2

TIP: The trick is to add light which goes from top to bottom. It makes tentacle look like 3D tentacle. If you want to make smaller or bigger tentacle just play with these settings.

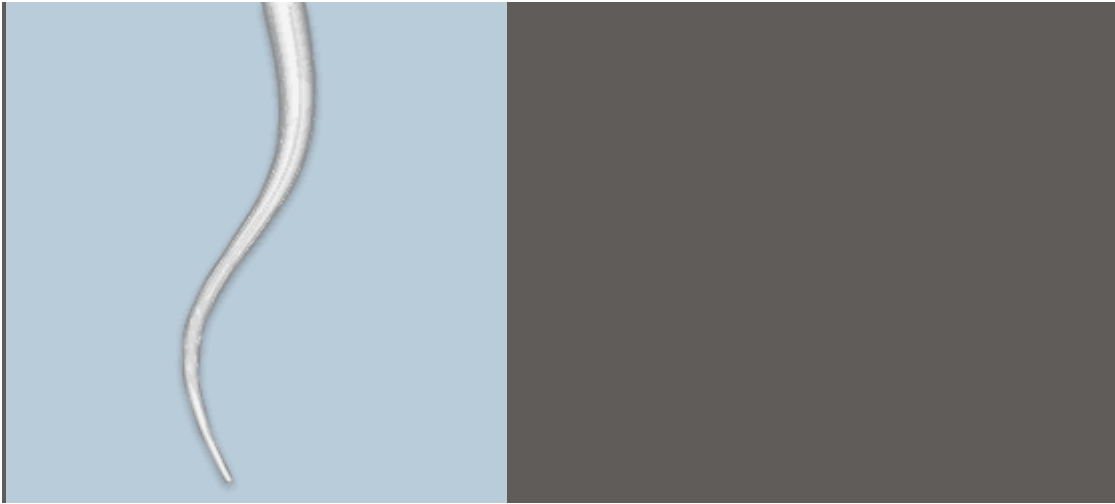

Step 7

Add some shadows. Use layer style - drop shadow with these settings:

Blend Mode: Normal

Color: Black

Opacity: 30 %

Angle: 90

Distance: 2

Spread: 0

Size: 5

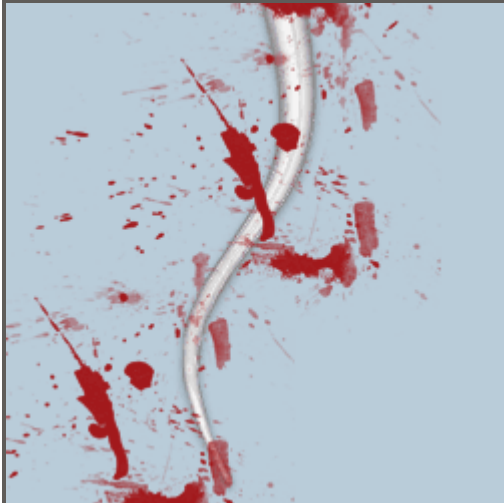

Step 8

This is the best part. We are going to cover this tentacle with BLOOD. Download some bloody brushes or use your own. I suggest you visit deviantart.com. There is a lot of great bloody brushes. It doesn't have to be blood. You can draw some spots using standard brushes. Create a new layer and name it "blood". Change the foreground color to #A2171A and splash some blood on the tentacle. Don't cover the whole tentacle.

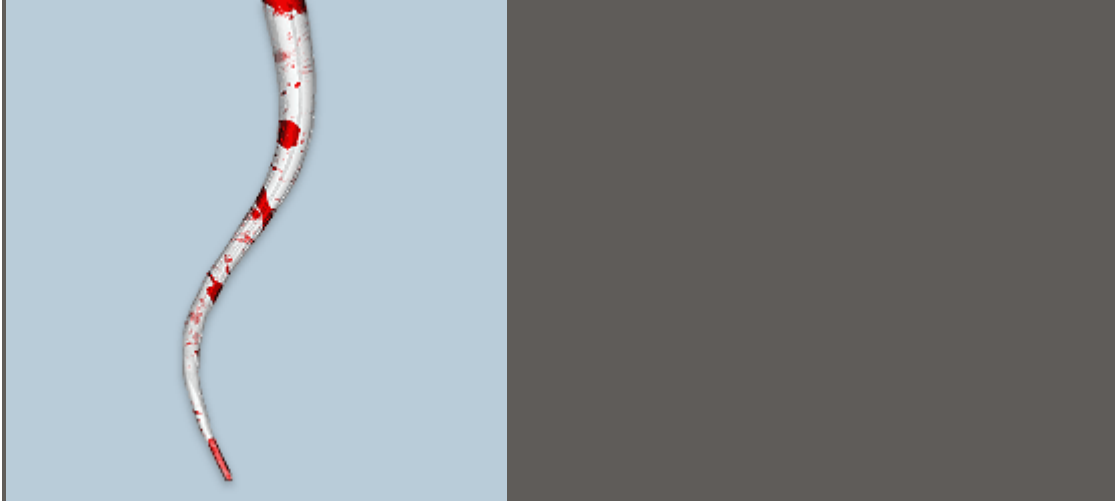

Step 9

Set the blending mode for the "blood layer" to Color Burn. While still on the blood layer hold CTRL and select "tentacle layer". Inverse a selection CTRL+SHIFT+I and hit DELETE. Now add some adjustments : Image> Adjustments> Brightness&Contrast and enter Brightness - 25.

Sharpen "tentacle layer". Filter>Sharpen>Sharpen. WOW!



Step 10

Final step is to add more blood spots to the background. Using this technique you can add anything to a tentacle like slime. All you have to do now is duplicate it.

REMEMBER : The key is to properly set Plastic Wrap Filter. Add more tentacles and have fun. Just be creative!

Congratulations, Your done!

PDF By: **Bernawolf_hatef**

Sir_hatef@yahoo.com

[Www.Bernawolf.coM](http://www.Bernawolf.coM)

<http://photoshop.Bernawolf.com>

Copyright © 2005 B.S.G (Bernawolf Software Group)